

# Minivator Stairlifts





# Discover the benefits of a Minivator stairlift



Designed with users in mind, the Minivator 1000 straight and 2000 curved stairlifts offer a safe, reliable, smooth way of overcoming the problems that some people encounter when faced with using their stairs.

Minivator, a quality registered company, prides itself on supplying superior service and quality solutions. Minivator has already helped thousands of people across the world gain access to areas in their homes and premises.

With additional powered features to choose from your lift can be tailored to meet your needs regardless of whether your staircase is straight or goes around corners.

Minivator stairlifts doesn't just offer an easy way of climbing stairs. On call 24 hours a day, 365 days a year, Minivator also offer you peace of mind and a long term solution.



Standard seat



SpaceSaver™ seat



Perch seat

Available in three variations to suit individual needs, all Minivator's seats are supplied with wipe clean, flame retardant upholstery in a choice of five colours. You can even replace upholstery later should you wish to change your colour scheme.



Unique toggle switch

Minivator's unique paddle switch makes Minivator stairlifts simple and safe to operate and can be fitted on either arm. Just hold the paddle in the direction of travel. Even those with limited mobility or with painful conditions such as arthritis find Minivator stairlifts easy to operate.



The perch seat (above), available on both the 1000 and 2000 stairlifts provides the ideal option for users with limited hip and knee flexibility.

one side whilst leaving the other free for side transfer if required.

Compact and unobtrusive, the seat, arms and footrest can all be folded to maximise the free space in hallways, on the landing or the the stairs.

Internal bend

Designed with input from occupational therapists, Minivator's operating paddle has been carefully located away from the surface of the armrest.

This gives you an ergonomically styled surface to hold when getting in or out of the seat.

The arms can also be lifted independently of each other to provide support on

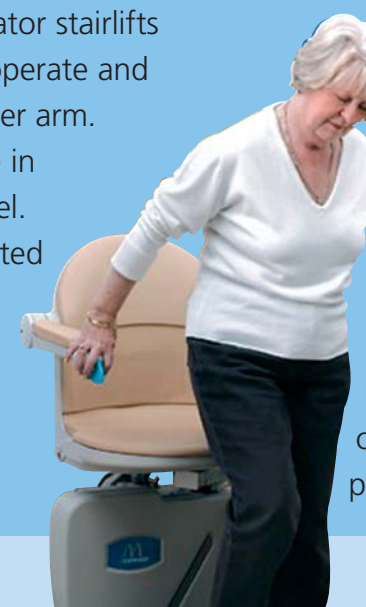

# Packed with features that make life easier



## HAND HELD REMOTE CONTROL

You can send your stairlift to the top or bottom of the stairs, or call it back with the remote control handset. Supplied as standard your remote controls can be wall mounted or handheld.



## POWERED SWIVEL

With a choice of powered or manual swivel turning the Minivator stairlift at the top of the stairs couldn't be easier. Simply retain pressure on the toggle switch at the end of your journey and the powered swivel will automatically turn you round to face the landing.



## MANUAL SWIVEL

Minivator's manual swivel system is operated from specially designed levers located on both sides of the stairlift. The manual swivel can be operated by pulling the lever up or pushing it down. This is especially useful if more than one person will be using the stairlift.



The Minivator 2000 track can be extended, space permitting. This means that the track would finish away from the stairs. This is particularly popular on landings allowing you to dismount directly onto the landing.



The footrest is designed to finish level with the landing making it easier to transfer feet from one surface to another.



## STRAIGHT AND CURVED TRACKS

Whether your staircase is straight or goes around corners Minivator stairlifts can supply the appropriate tracks to meet your needs. The Minivator 2000 can even accommodate spiral staircases.

As with Minivator's seats aesthetics are considered carefully. The 1000's hidden rack system provides a compact slim line solution that nestles into the edge of the stairway.

Available in two colours as standard the 2000 track can in fact be supplied in any RAL colour as a special order.



Every Minivator 2000 track is bespoke allowing you to take advantage of Minivator's excellent manufacturing and design prowess. Your track is optimised to give you the best travel possible whilst fitting snugly to your wall or banister regardless of how it is configured.



With a skilled and dedicated research team Minivator's passion for producing the best solutions resulted in the tightest internal curve available from any stairlift manufacturer. In many cases the Minivator internal curve allows a stairlift to be fitted in locations that no other manufacturer can accommodate.

## HINGE TRACKS



You need not worry that doorways will be obscured or that tracks will cause excessive trip hazards. Minivator hinge tracks are available on both the 1000 and 2000. Operated from the handset the track can be folded to eliminate trip hazards or leave doorways unobstructed. The 1000 can also be supplied with a manual hinge.

Both tracks are designed to fit closely to the edge of the stair. This minimal intrusion leaves the stairway clear for other users.



# Safety as standard



Rapid response safety sensors stop the stairlift if it meets with an obstruction during travel. Once the obstruction is removed the stairlift can continue on its journey.



## POWERED FOOTREST

Finished with a durable anti-slip carpet the footrest folds away easily. Should you wish you may choose a powered footrest link that will automatically fold your footrest up or down when the seat is folded, removing the need to bend. Minivator stairlifts also come with a battery back up as standard meaning that you need not worry about being stranded in the event of a power cut.



Supplied with a clip seatbelt as standard you can also choose from Velcro and retractable seatbelts once again allowing you to customise your stairlift to provide a solution that meets your needs and preferences.



Discreetly hidden from view under the armrest the lockable key switch allows you to prevent unauthorised use of your stairlift



With four height settings your stairlift can be adjusted to suit your needs.

## Examples of Minivator's versatile track configurations

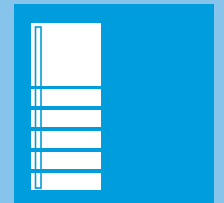

1000 Series.

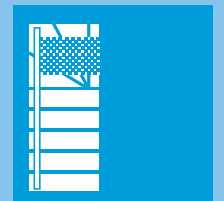

1000 Series with platform.

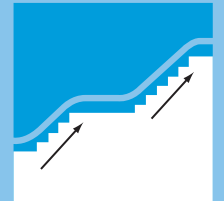

2000 Series. Intermediate landing, top overrun, bottom overrun.

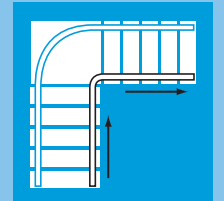

2000 Series. Quarter landing (90 degree flat curve).

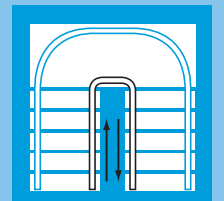

2000 Series. Hall landing (180 degree flat curve).

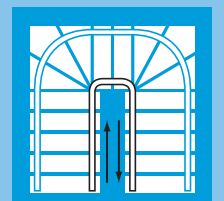

2000 Series. Helix bends (90 or 180 degree).



# Minivator STAIRLIFTS

	1000	2000
<b>A</b> Minimum swivel radius	725mm <sup>#A</sup>	740mm <sup>§A</sup>
<b>B</b> Minimum wall to seat back	148mm <sup>#B</sup>	170mm <sup>§B</sup>
<b>C</b> Seat depth	400mm	400mm
<b>D</b> Minimum folded width to footplate	387mm	400mm
<b>E</b> Minimum open width to edge of footplate	674mm	668mm
<b>F</b> Armrest width – external	560mm	560mm
<b>G</b> Armrest width – internal	440mm	440mm
<b>H</b> Seat back height	420mm	420mm
<b>I</b> Footplate to seat height – standard seat	455mm min*	481mm min**
<b>I</b> Footplate to seat height – perch seat	530–880mm <sup>†</sup>	700–800mm**
<b>J</b> Minimum footplate height	75mm	70mm
Minimum track intrusion into staircase	142mm	116mm
Minimum track intrusion into top landing – (typical at 45°)	86mm	—
Weight capacity	137kg/21stone <sup>†</sup>	
Speed	0.12m/sec (approx)	
Power supply	24v DC battery	
Charger	240v	
Maximum staircase angle	56°	

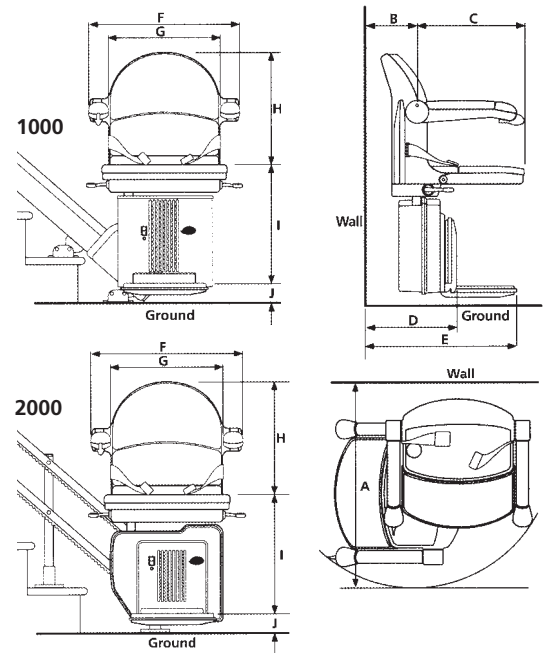

BUTE

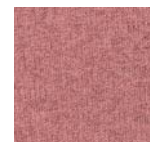

KERRY PINK



FIVE GREEN



BRECHIN GREEN

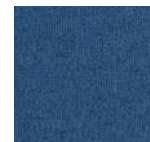

SKY BLUE



LEWIS RED

<sup>#</sup>SpaceSaver™ seat A and B dimensions 687mm and 80mm respectively

<sup>§</sup>SpaceSaver™ seat A and B dimensions 740mm and 137mm respectively

\* 50mm increments + 20mm offset    † 25mm increments + 20mm offset

\*\* 3 x 25mm increments

<sup>‡</sup> Minivator 1000

<sup>†</sup> Dependent on option chosen

## Also available from Minivator



Through the floor lifts



Domestic elevators



Step lifts



Inclined platform lifts



Vertical platform lifts



Bath lifts



## Minivator Limited

82 First Avenue, Pensnett Estate, Kingswinford, West Midlands, DY6 7FJ, England

Tel: +44 (0) 01384 408700 Fax: +44 (0) 1384 408719

Email: sales@minivator.co.uk Website: www.minivator.co.uk



Your local Minivator dealer:

Dolphin Mobility Ltd  
37 Chertsey Road  
Chobham, Surrey  
GU24 8PD  
T: 01276 856060  
www.dolphinlifts.co.uk

0604:2

Please be aware that actual colours may vary slightly from those shown here. All information is provided in good faith but does not constitute a guarantee. Minivator Limited reserves the right to alter designs and specifications without prior notice.